

# TREND

cod. ASTD

**EN** A basic model, small in its dimensions, available with many different combinations of seals and plungers. Despite its simplicity this product can guarantee great acoustic performances, from 32 dB to 39 dB noise reduction depending on the type of seal.

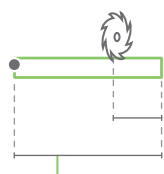

### trimming

200 mm standard  
50 mm | l. 330 mm  
135 mm | l. 430 mm

### lengths

330 430 530 630 730 830 930 1030 1130 1230 mm

### certification



### application

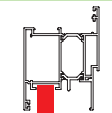

ALUMINIUM  
DOOR

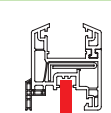

PVC  
DOOR

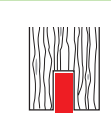

TIMBER  
DOOR



SECURITY  
DOOR

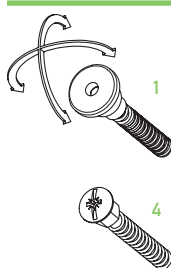

### plunger type



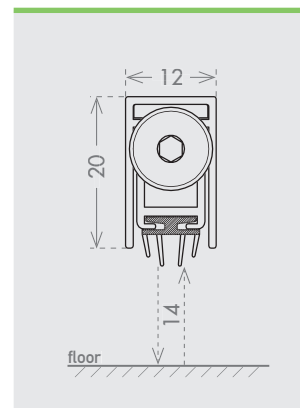

size 12x20 mm



### seals

<p><b>A</b></p>  <p>THERM</p> <p><b>32 dB Rw</b> IFT Cert. n. PB-G03-04 en-01_PB22</p>	<p><b>B</b></p>  <p>SIL</p> <p><b>37 dB Rw</b> IFT Cert. n. PB-G03-04 en-01_PB20</p>
---	---

<p><b>C</b></p>  <p>THERM</p> <p><b>39 dB Rw</b> IFT Cert. n. PB-G03-04 en-01_PB19</p>	<p><b>D</b></p>  <p>PP</p>
---	---

### fixing type

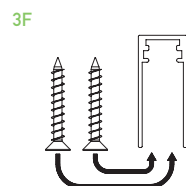

### closing plug included



### optional

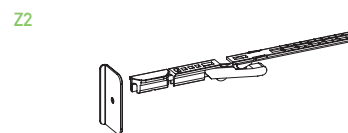

**DOUBLE PLUNGER KIT**  
cod. ACKITDP p. 152

**ACTUATOR PIVOT** cod. ACAPIV p. 153

**IT** Modello semplice e di piccole dimensioni ma con buone proprietà di abbattimento acustico, disponibile in molte combinazioni di pulsanti e guarnizioni. A seconda della guarnizione scelta si possono ottenere abbattimenti acustici che vanno dai 32dB ai 39dB, risultati eccezionali per una guarnizione automatica così semplice e compatta.

**DE** Einfaches und platzsparendes Modell mit guten Schalldämmeigenschaften. Mit vielen Druckknopf- und Dichtlippenkombinationen erhältlich. Je nach gewählter Dichtlippe können Schalldämmwerte von 32 dB bis 39 dB erzielt werden, was für so eine einfache und kompakte Türdichtung wirklich außergewöhnlich ist.

**FR** Modèle offrant des dimensions réduites tout en conservant de bonnes performances acoustiques, disponible dans de nombreuses combinaisons de bouton poussoir et de joints. En fonction du type de joint sélectionné, un abattement acoustique de 32 à 39dB peut être obtenu, résultats exceptionnels pour une plinthe si petite.

**ES** Modelo sencillo y de tamaño reducido pero con buenas propiedades de aislamiento acústico, disponible en muchas combinaciones de pulsadores y juntas. Según la junta elegida, se pueden conseguir reducciones de emisiones acústicas que van desde los 32 dB a los 39 dB, resultados excepcionales para una junta automática tan sencilla y compacta.

**RU** Эта простая модель небольших размеров обладает хорошими характеристиками снижения уровня шума и поставляется с многими сочетаниями кнопок и уплотнителей. В зависимости от выбранного уплотнителя можно получить снижение уровня шума от 32 до 39 дБ, что является отличным результатом для столь простого и компактного автоматического уплотнителя.